

azur

851N

Network Player

Cambridge Audio

Your music, our passion



Contents

Rear panel connections.....	3
Front panel connections.....	3
Remote control.....	4
Getting connected.....	4
Network connections.....	4
Character entry.....	5
Operating instructions.....	5
Inputs.....	6
Settings.....	6

Important!

The 851N is largely a software based product and new features and updates will be made available from time to time. See the Upgrade Firmware section at the end of this manual for how to check for and then automatically update your unit via the internet. The process takes only a few minutes.

We would encourage you to check for any updates before using your 851N for the first time and then from time to time afterwards.

Also please do check the support page for the 851N at <http://techsupport.cambridgeaudio.com> for details of any new features, advice on compatibility with other products and audio formats and the most recent copy of this manual.

Make sure you register your purchase.

Visit: www.cambridgeaudio.com/vip

By registering, you'll be the first to know about:

- **Future product releases**
- **Software upgrades**
- **News, events and exclusive offers plus competitions!**

© Copyright Cambridge Audio Ltd 2015.

Stream Magic is a trademark of Audio Partnership Plc and is registered in the European Community and other countries.

This product contains software licensed under version 2 of the GNU Public License and version 2.1 of the GNU Lesser Public License. The source code for this software is available from:

<http://gpl.stream-magic.com/>

This product includes technology owned by Microsoft Corporation and under a licence from Microsoft Licensing GP. Use or distribution of such technology outside of this product is prohibited without a license from Microsoft Corporation and/or Microsoft Licensing, GP as applicable.

The Spotify software is subject to third party licenses found here: www.spotify.com/connect/third-party-licenses.

Rear panel connections

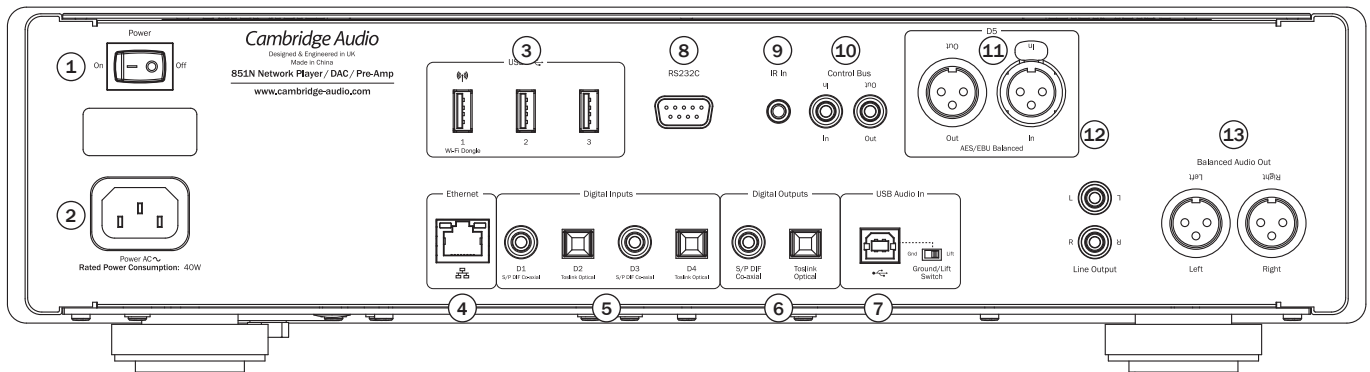

1 Power on/off

2 AC power socket

3 USB sockets

For connection to the supplied Wi-Fi antenna, USB HD/flashdisk or optional BT100 Bluetooth audio receiver.

Note: For Wi-Fi antenna, this must be plugged into the USB port 1. The USB ports are not intended for connection to Apple mobile devices, no functionality, charging or otherwise is supported.

4 Ethernet

5 Digital inputs

6 Digital outputs

7 USB audio in

For connecting to PC/MAC computers.

Ground lift switch

Enable 'Lift' to eradicate hum noise through the speakers.

8 RS232C

For control in a custom installation (for protocol please visit our website).

9 IR (Infra Red) emitter in

10 Control bus

For connection to other azur 8-series products. Features vary according to other product functionality.

11 AES/EBU balanced

For digital audio connections suitable for 16-24 bit content up to 192kHz.

12 Unbalanced audio output

13 Balanced audio output

For use with XLR connections.

Note: XLR connectors should be wired as follows: Pin 1: Ground, Pin 2: Hot (in-phase) and Pin 3: Cold (phase-inverted).

Front panel connections

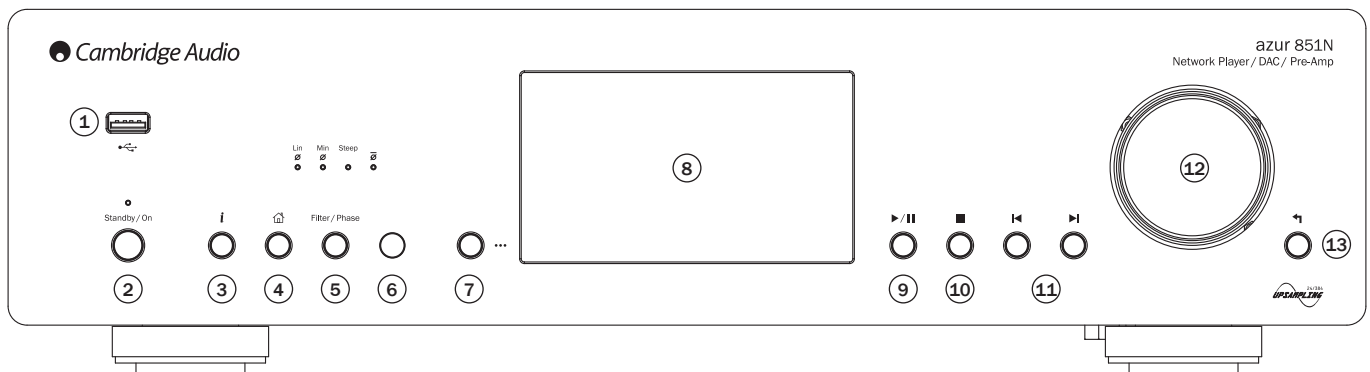

1 USB

For use with USB audio storage. 1A maximum current consumption.

Note: This USB port is not intended for connection to Apple mobile devices.

2 Standby/On

3 (i) Info

Displays 'Now Playing' screen. Press to toggle through various screen layouts.

4 Home

5 Filter

Press to toggle through three alternative digital filter characteristics

Phase

Press and hold for approximately two seconds to select normal or inverted (LED lights up) phase output.

6 Infrared sensor

7 (More)

When playing Internet Radio, the More button displays related options to the currently selected station such as alternative stream types, content types or similar stations. When playing from UPnP sources, this button displays queued tracks and options.

8 Display

Displays the status of the unit.

9 Play/Pause

Press during playback to stop or delete items in various menus.

10 Stop/Delete

Press to return to the previous menu.

Press during playback to stop or delete items in various menus.

Press during playback to stop or delete items in various menus.

Press during playback to stop or delete items in various menus.

Press during playback to stop or delete items in various menus.

Press during playback to stop or delete items in various menus.

Press during playback to stop or delete items in various menus.

Remote control

1. Standby/On

2. Display brightness

3. Presets

Recalls stored 1 - 4 presets.

4. Mute (Pre-amp mode)

5. Enter/Mode

6. Volume (Pre-amp mode)

7. Home menu

8. Return

9. Skip

Skips between tracks.

10. Backlight button

Illuminates the buttons.

11. Info

Toggles between display information.

12. Navigation

13. Stop/Delete

14. Play/Pause

15. Queue

For USB audio media only.

16. (More)

When playing Internet Radio, the More button displays related options to the currently selected station such as alternative stream types, content types or similar stations. When playing from UPnP sources, this button displays queued tracks and options.

17. Digital inputs

18. Random

19. Repeat

20. Filter

Press to toggle through the three digital filter options.

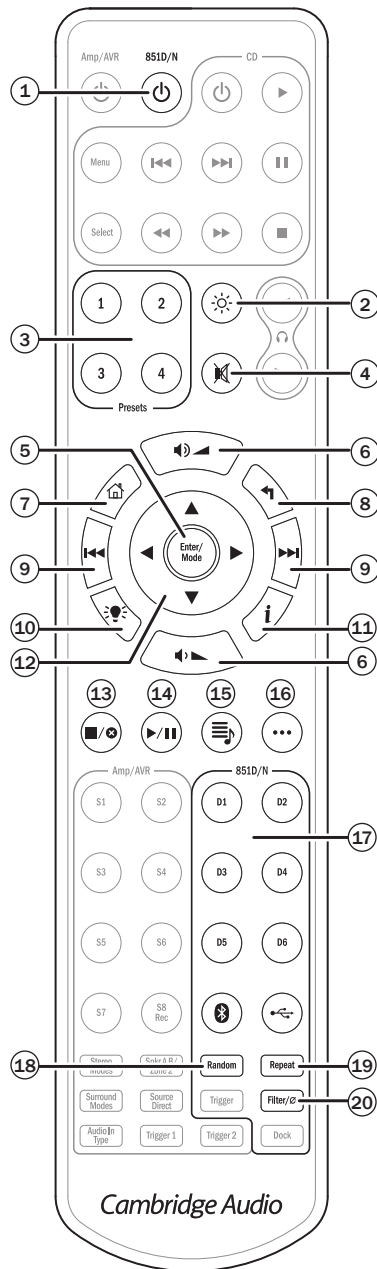

Getting connected

Basic audio connections

Switch the power off before making any connections.

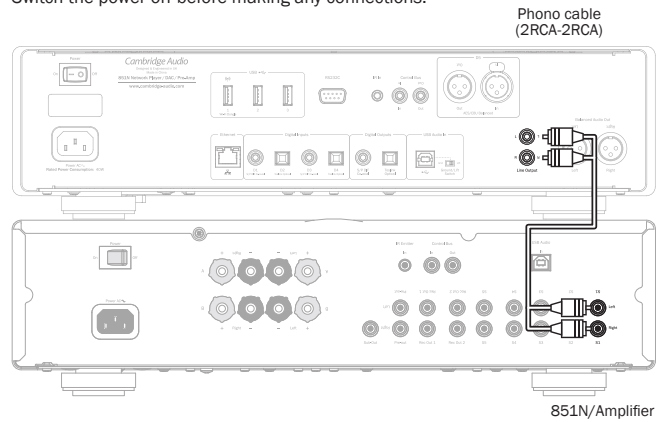

Network connections

To use the UPnP media sharing feature, you will need either a wired Ethernet or Wi-Fi connection to your network

To use internet radio, Streaming Services or to receive product software updates you will also need a broadband internet connection.

Use a wired connection for seamless playback of high resolution 24/176 and 24/192 files.

Connecting to a wired network

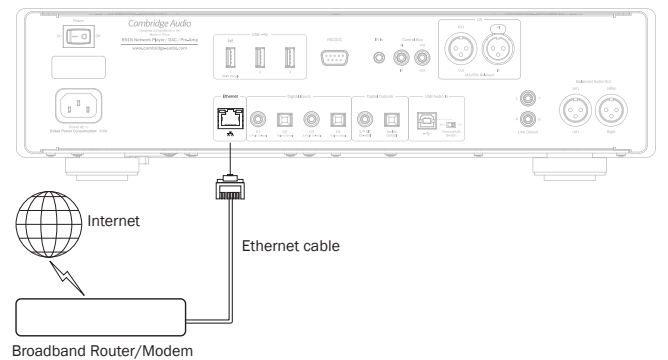

Connect a network cable (Category 5/5E straight through Ethernet cable) between the 851N and your router.

Connecting to a wireless network

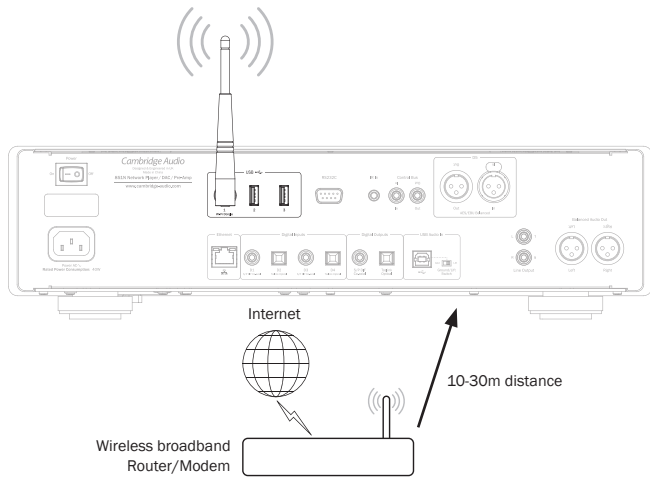

Connect the supplied wireless antenna to the correct USB input on the rear of 851N – it will need to be in range of your wireless router.

On an iOS device go to Wi-Fi settings and select '851N'.

Alternatively, connect the 851N directly to the Wi-Fi network: Select your Wi-Fi network and then enter your password.

Note: Wi-Fi network passwords are case sensitive.

For further information on 851N network settings please see the "Settings >> Network" section later in this manual.

Character entry

This is typically for:

- Wi-Fi network password.
- Searching for radio stations and content on UPnP servers.
- Customising the 851N's "friendly" name and digital input names.

A	B	C	D	E	F	G	H	I	J	K	L	M	N	O	P	Q	R	S	T
U	V	W	X	Y	Z	0	1	2	3	4	5	6	7	8	9	<		=	>
+	-	_	!	?	@	#	\$	%	^	&	*	:	;	'	"	.	,	\	
/	[]	{	}	()	~												

✘	←
	↵

To enter text:

1. Use the front panel rotary encoder to scroll through each symbol.
2. Using the IR remote control, you can navigate horizontally and vertically.
3. Press Enter on the front panel or IR remote to select the highlighted character.

← deletes the last character selected (equivalent to the ■ button on the front panel or IR remote control).

✘ cancels the text entry process.

↵ submits the entered text.

Operating instructions

Music Library

The Music Library menu item lists all found UPnP servers and USB media devices.

There are many suitable UPnP server software packages available for PC and Mac. Stand-alone servers and Network Attached Storage (NAS) devices with built in UPnP server capabilities are also available. Please see the set-up guides on our website at: www.cambridgeaudio.com/networksetup

Note: When using a UPnP server to share your media, the menu structure, search and selection criteria are determined by that server, not the 851N.

The 851N does not scan entire USB storage devices to build an artist/track database. It is therefore recommended that audio files are stored in a structured way by artist and album to facilitate locating tracks.

Playing tracks and adding to the queue

Add individual tracks or albums

Selecting an individual track will show the following menu:

- PLAY NOW
- PLAY NEXT
- ADD TO QUEUE – Add the track to the end of the queue
- REPLACE QUEUE – Remove all queue items and replace with the new track

Viewing the Queue

To view the queue at any time press the '...' (more) button.

You can jump playback to any point in the queue by navigating up/down the list and pressing Enter.

Editing the Queue

Tracks can be removed from the queue by highlighting them with the navigator and pressing the Stop button.

To clear an entire queue, navigate to the bottom of the queue to highlight [Clear Queue] and press Enter.

Note: Switching the 851N into standby will delete the queue, unless Standby Mode is set to 'Network Standby'.

The 'Now Playing' screen

Pressing the 'i' button will cycle through:

- Combination of track/stream info plus album/station art
- Just album/station art
- Just track/stream info

Album art and radio station logos may also be displayed if available. For USB Media the Album art needs to be in the same folder as the track.

Album art file format

Album art images are supported in .png and .jpg file formats only.

Images can have any name, but images named Folder.png or Folder.jpg take precedence.

Images embedded into tracks are not supported.

Playlists

The 851N supports various playlist formats:

- ASX (Microsoft® playlist format)
- M3U
- PLS

For permanent storage of favourite media selections it is recommended to use suitable software to create playlists. These can then be accessed by the 851N from USB storage devices or UPnP servers that support playlist serving.

It is not currently possible to save playlists created on the 851N.

Cambridge Audio

Inputs

USB Audio

The 851N USB Audio input is intended to connect directly to a PC or Mac computer.

The default 851N configuration is USB Audio profile 1.0 which works with nearly all common operating systems and computer types without needing additional drivers. In this configuration sample rates from 16-bit/32kHz to 24-bit/96kHz are supported.

For more details on USB Audio, see our online guides at: www.cambridgeaudio.com/USB-audio

D1-D5

The five digital inputs are capable of receiving stereo PCM audio with sample rates up to 24-bit/192kHz.

Bluetooth

The optional Cambridge Audio BT100 Bluetooth dongle can be connected into any available USB socket.

Spotify connect

Spotify lets you listen to millions of songs – the artists you love, the latest hits and discoveries just for you. If you are a Spotify Premium user, you can control your 851N using the Spotify app.

1. Connect your 851N to the same Wi-Fi network as your phone or tablet running the Spotify app.
2. Open the Spotify app, and play any song.
3. Tap the song image in the bottom left of the screen.
4. Tap the Connect icon .
5. Pick your 851N from the list.

For information on how to set up and use Spotify Connect please visit www.spotify.com/connect.

The Spotify Software is subject to third party licenses found here: www.spotify.com/connect/third-party-licenses.

Settings

Get Registration Key

Used to generate a unique temporary code, allowing the 851N to be registered with your Stream Magic website account at www.stream-magic.com.

Network

Set-up Wi-Fi: Initiates Wi-Fi setup.

Enter network name: For manual entry of the network name.

Current Config: Displays current network settings.

Edit Config:

- Auto (DHCP)
 - YES (recommended)
 - NO – settings are manually entered

If 'NO' is selected, you will need to enter (using the navigator and select buttons) the 851N's IP address, Network mask, Gateway address and DNS server(s).

Wi-Fi Strength

Signal Warning: On-screen warning of low Wi-Fi signal strength.

Wi-Fi Region: Select the region that closest matches your location.

Wired/Wi-Fi:

- Auto (default)
- Wired Only
- Wi-Fi Only

Firmware

- Check for updates and display version number.

Display Brightness

Device Name

Rename the 851N.

Audio

- Digital Pre-amp Mode
 - On – enables volume control
 - Off – Fixed output
 - Balance – only available if Digital Pre-amp Mode = On
- USB Audio Class
 - 1.0 – for greatest compatibility with computers
 - 2.0 – allows high sample rate audio (up to 24-bit/192kHz sample rate. You may need to download and install the Cambridge Audio USB Audio class 2.0 driver.

For further information on USB Audio: www.cambridgeaudio.com/USB-audio

Remote Code

Used when there is a clash with other products.

- 8 Series Handset (24) (default).
- 8 Series Handset (27) – alternate set IR remote control commands.
- No IR control – disables the 851N from responding to IR remote control commands

To use the alternate set IR remote control commands, both the 851N and the 851N IR remote control handset must be reconfigured:

- 851N – select 8 Series Handset (27) in the above menu.
- Remote control – perform the following steps:
 - Remove the batteries from the 851N IR remote control
 - Press and hold the 'DAC/SM' button while reinserting the batteries

Note: To restore the default 851N IR remote control command set, remove and reinstall the batteries without pressing any buttons.

Language

Standby Mode

- Network Standby – network connections remain active and the Cambridge Connect app can turn on the 851N.
- ECO mode – all audio, network and control circuits are shut down.

Automatic Power-down

Sets the time before entering Standby Mode after inactivity.

Edit Input Names

Allows you to customise the names of the digital inputs; USB Audio and D1 – D5.

Factory Reset

Restores the 851N to the default factory shipping state.

Note: Factory reset will delete all Wi-Fi networks and keys from memory; however Presets associated with your Stream Magic website account remain.

Cambridge Audio is a brand of Audio Partnership Plc
Registered Office: Gallery Court, Hankey Place
London SE1 4BB, United Kingdom
Registered in England No. 2953313

www.cambridge-audio.com

